

# TS-615/625形

## ❖ 外形図

### ▼ TS-615形

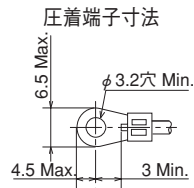
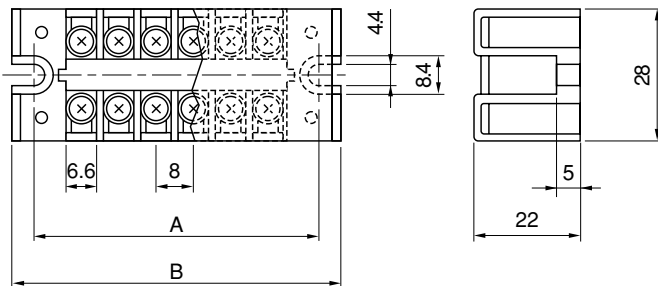

寸法表 (単位:mm)

極数	2P	3P	4P	6P	8P	10P	12P	14P	16P
A	28	36	44	60	76	92	108	124	140
B	38	46	54	70	86	102	118	134	150

製品重量 (単位:g)

極数	2P	3P	4P	6P	8P	10P	12P	14P	16P
重量	13	17.5	22	31.5	40.5	49.5	60	69	78

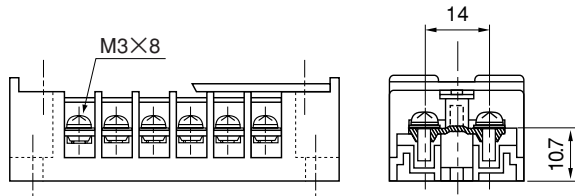

### ▼ TS-625形

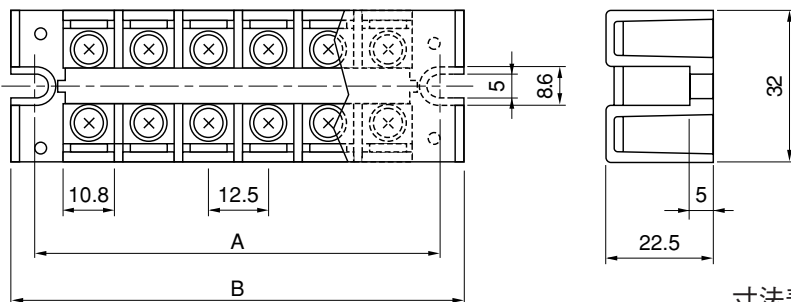

圧着端子寸法

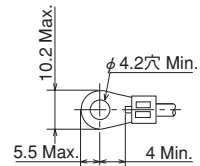

寸法表 (単位:mm)

極数	2P	3P	4P	6P	8P	10P	12P	16P
A	34	46.5	59	84	109	134	159	209
B	44	56.5	69	94	119	144	169	219

製品重量 (単位:g)

極数	2P	3P	4P	6P	8P	10P	12P	16P
重量	23	32	41	59	77	95	113	149

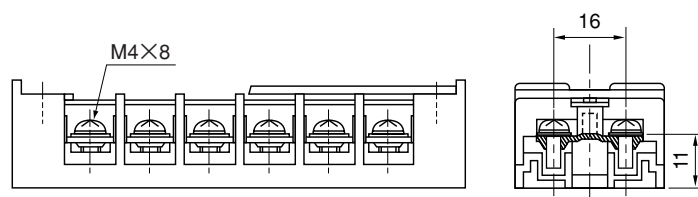

### ● ショートバー

#### ▼ J-615 (TS-615用)

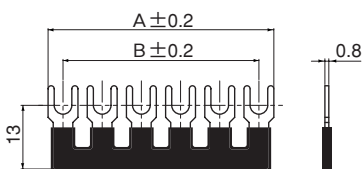

#### ▼ J-625 (TS-625用)

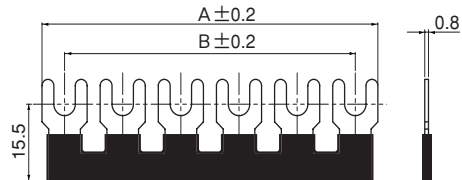

寸法表 (単位:mm)

形式	極数			
	2P	3P	6P	10P
J-615	A	14.1	22.1	46.1
	B	8	16	40
J-625	A	22.2	34.7	72.2
	B	12.5	25	62.5

端子台